

# SPAZIO

MUTO acoustic  
wall tile solutions

---

 SOELBERG

# SPAZIO

## MUTO acoustic wall tile solutions

Introducing MUTO Acoustic Tile Mania. With bold geometric forms, Spazio Tiles create dimension with shape and shadow to absorb that unwanted noise. With a variety of unique profiles that interact together and endless color options to choose from, mix and match to create your very own functional wall art. With our two week manufacturing lead time, your curated walls come together in no time at all.

### SPECIFICATION

<b>CONTENT</b>	100% POLYESTER (PET) FELT
<b>CORE THICKNESS</b>	1/2" (12MM)
<b>TILE</b>	7 UNIQUE TILE PROFILES
<b>COLOR</b>	27 STANDARD COLORS 12 WOODED GRAINS 4 PRINT COLORS
<b>WEIGHT</b>	2 1/2 - 3 LBS   EACH TILE
<b>DIMENSIONS</b>	SIZE: 16" x 16" MIN DEPTH: 1.5" MAX DEPTH: 3.5"
<b>ORIENTATION</b>	WALL APPLIED   ROTATE AS DESIRED
<b>WALL ATTACHMENT</b>	MUTO CLEAT OR OTHER
<b>ACOUSTICS</b>	1.10 NRC
<b>FIRE RATING</b>	CLASS A   ASTM - E84
<b>ENVIRONMENTAL</b>	DELICARE, MINDFUL MATERIALS & GREENGUARD GOLD CERTIFIED. MUTO IS PRODUCED FROM 100% RECYCLABLE PET FELT WITH A MINIMUM OF 60% PRE-CONSUMER RECYCLED CONTENT.
<b>COLORFASTNESS</b>	IN ACCORDANCE WITH ATCC 16.3 OPTION 3 THE COLOR CHANGE TO LIGHT AT 20 AFU WAS 4.5.
<b>FINISH</b>	MATTE
<b>APPLICATION</b>	INDOOR USE ONLY
<b>LEAD TIME</b>	2 WEEKS
<b>WARRANTY</b>	2 YEARS



### TOLERANCE & MAINTENANCE

PET core is a soft fibrous material. All dimensions and squareness are subject to +/- 1/16" tolerance.

Vacuum to remove dirt and dust. Remove spills or spots immediately using a clean damp cloth. Carpet and fabric cleaners can also be used to clean. (Always test an inconspicuous area first.) Compressed air may be used to dust in difficult or hard-to-reach areas. To disinfect, bleach can be used in accordance with CDC Cleaning & Disinfection instructions. The solution ratio is 5 tablespoons of bleach to 1 gallon of water | 4 teaspoons of bleach to 1 quart of water. Apply solution by spray and wipe off immediately. (Always test in an inconspicuous area first.)

# TILE

## 7 PROFILES

16" x 16" WIDTH & HEIGHT

RANGE FROM 1.5" TO 3" DEPTH

ALL TILE PROFILE INTERACT AND CAN BE USED TOGETHER TO MAKE YOUR VERY OWN DIMENSIONAL WALL ART. ROTATE TILES 90°, 180° OR 270° FOR ENDLESS PATTERN OPTIONS.



ALTO [all - toe]

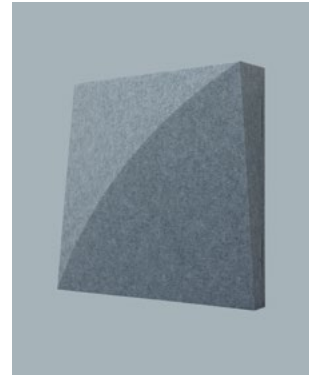

ARCO [are - koe]



BASSO [bah - sew]

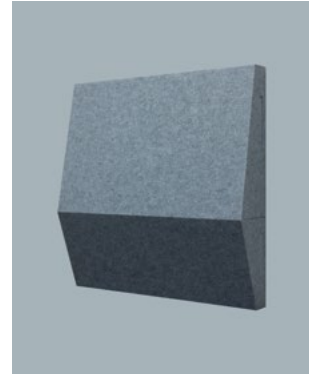

CIMA [chee - mah]

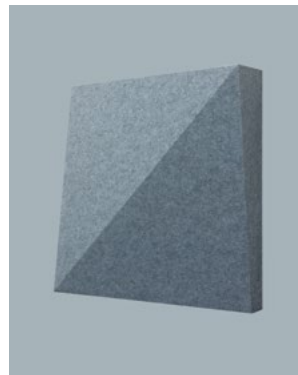

PICCO [peek - oh]

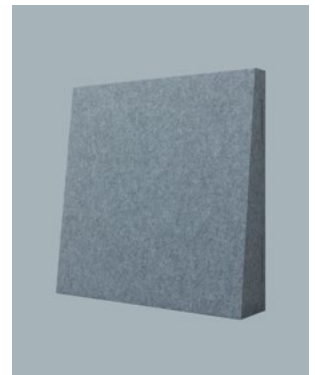

TUTTO [too - toe]

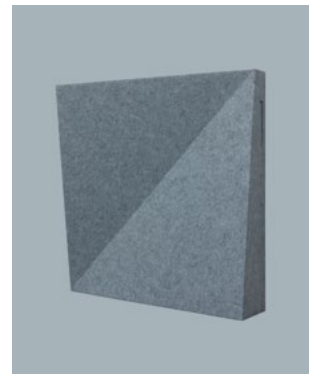

VALLE [vah - lay]

# COLOR

## MATTE COLOR

27 STANDARD COLORS  
CUSTOM PRINT COLORS AVAILABLE  
(CONTACT YOUR LOCAL SALES REP)  
100% RECYCLABLE PET FELT

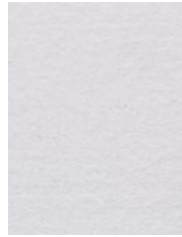

WHITE

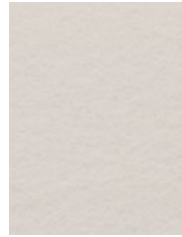

BONE

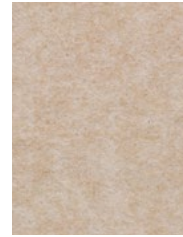

OATMEAL

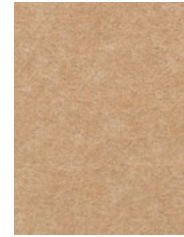

CAMEL



SAND

## TOLERANCES

PET felt is made from 100% recyclable polyester plastic. Variation in depth will occur. Slight and consistent variations in color, density, texture are inherent to this core material and should be expected. Color, density and texture will vary by dye lot. MUTO is made with a 'felling' process which results in a textural heathered effect where the fibers consist of multiple tones and shades.



CASHMERE



FOG

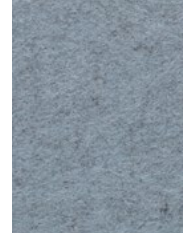

LAMB'S EAR

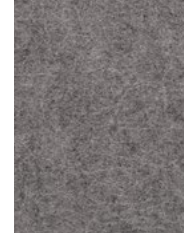

PEWTER



NORDIC KNIT

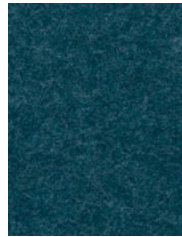

WINTER WATER

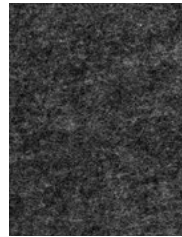

GRAPHITE



BLACK



MIDNIGHT



BLUEBERRY



JUNIPER



SPLASH



STORM

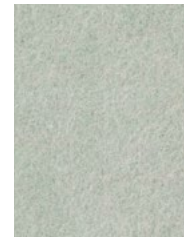

SEAFOAM



SAGE



ARTICHOKE



LICHEN

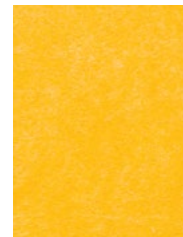

SUNSHINE

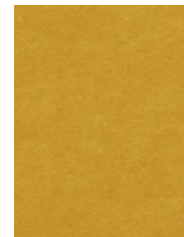

QUAKING ASPEN



CLEMENTINE



CHILI PEPPER



CURRANT

# WOODED COLOR

## MATTE FINISH

12 PRINTED WOODED GRAINS  
1/2" CORE THICKNESS

## TOLERANCES

PET felt is made from 100% recyclable polyester plastic. Variation in depth will occur. Slight and consistent variations in color, density, texture are inherent to this core material and should be expected. Color, density and texture will vary by dye lot. MUTO is made with a 'felting' process which results in a textural heathered effect where the fibers consist of multiple tones and shades.

## TILE GRAIN DIRECTION

GRAIN FOLLOWS ARROW

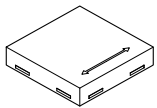

ALTO

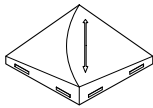

ARCO

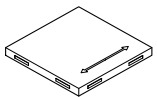

BASSO

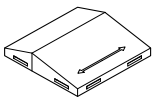

CIMA

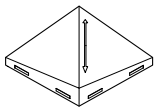

PICCO

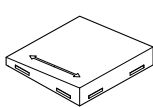

TUTTO

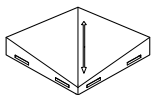

VALLE



WHITE WASHED OAK

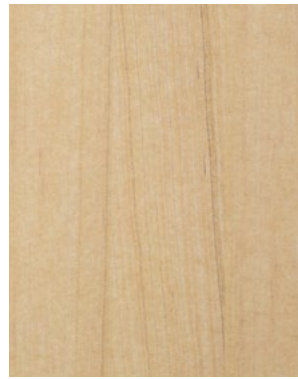

BLONDE MAPLE



NATURAL ASH



AGED ASH



SMOKED ASH



AMBER ASH



WARM WALNUT



NATURAL WALNUT



BLACK WALNUT



WEATHERED PINE



CARBON PINE



CHARRED OAK

## PRINT COLOR

### MATTE FINISH

4 PRINTED COLORS

1/2" CORE THICKNESS

\*\*\*CUSTOM COLORS AVAILABLE

## TOLERANCES

PET felt is made from 100% recyclable polyester plastic. Variation in depth will occur. Slight and consistent variations in color, density, texture are inherent to this core material and should be expected. Color, density and texture will vary by dye lot. MUTO is made with a 'felting' process which results in a textural heathered effect where the fibers consist of multiple tones and shades.

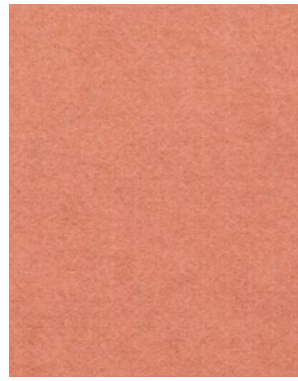

DESERT ROSE



DARK CLAY



RIVER

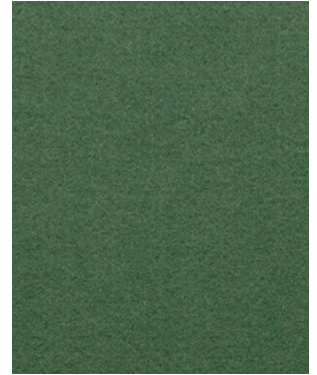

SAP GREEN



# DIMENSIONS

## 7 TILE PROFILES

TILE SIZE: 16" x 16"

TILE MINIMUM DEPTH: 1.5"

TILE MAXIMUM DEPTH: 3.5"

DISCLAIMER: EACH MUTO SPAZIO TILE HAS TWO VISIBLE TABS ON EACH SIDE. WOOD GRAIN AND PRINTED TILES WILL HAVE A CONTRASTING TAB ON EACH SIDE.

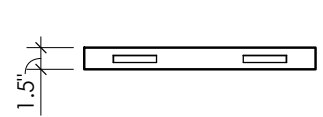
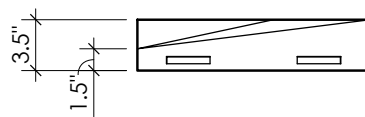
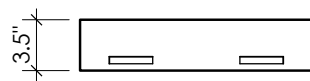
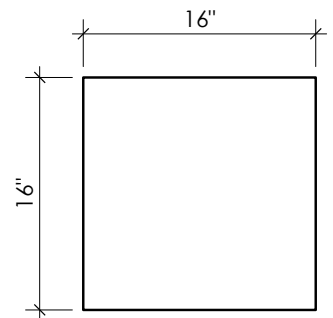
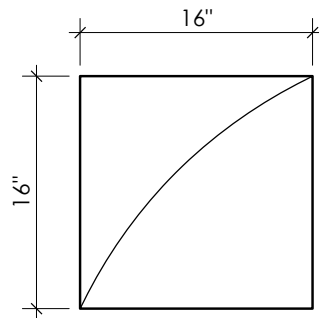
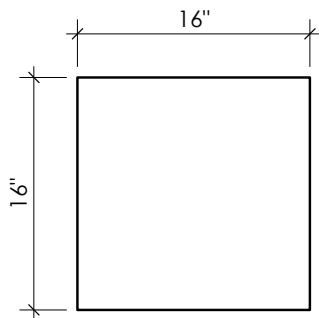
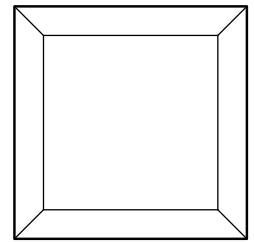
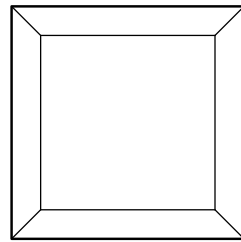
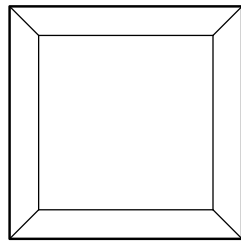
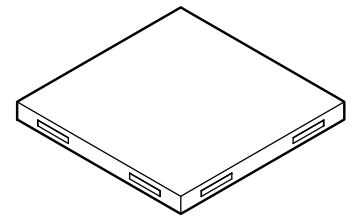
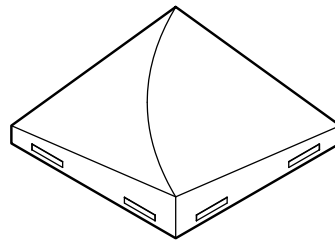
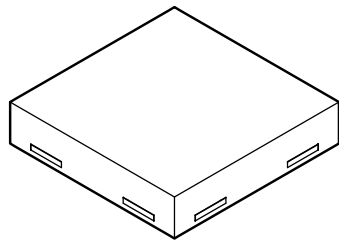

ALTO DIMENSIONS  
WEIGHT: 3 LBS

ARCO DIMENSIONS  
WEIGHT: 2.8 LBS

BASSO DIMENSIONS  
WEIGHT: 2.4 LBS

# DIMENSIONS CONTINUED

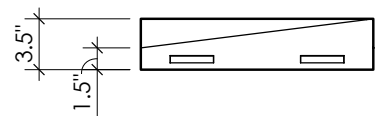
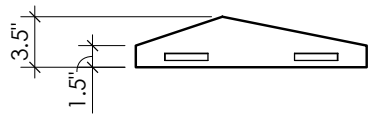
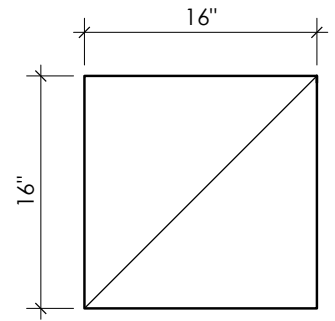
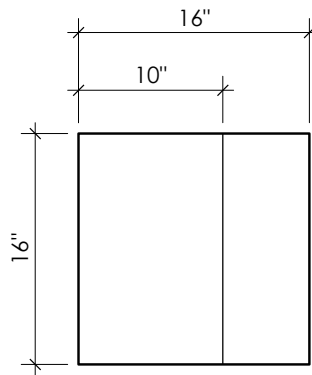
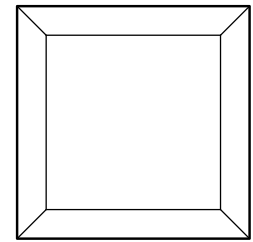
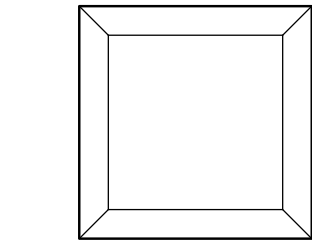
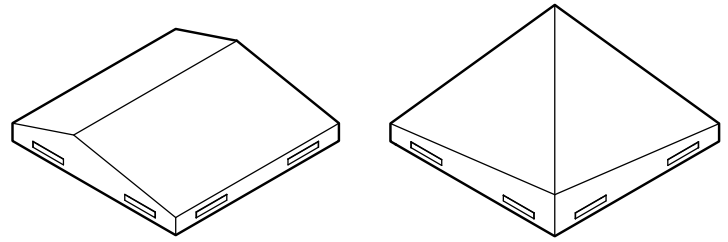

CIMA DIMENSIONS  
WEIGHT: 2.6 LBS

PICCO DIMENSIONS  
WEIGHT: 2.7 LBS





# DIMENSIONS CONTINUED

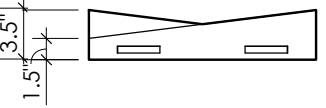
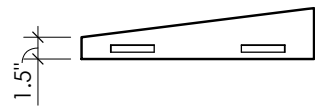
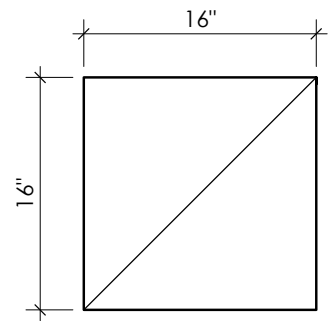
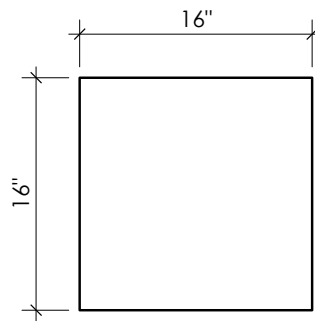
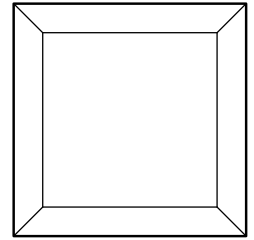
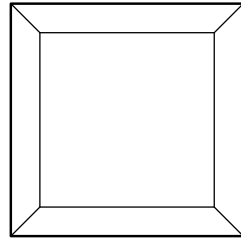
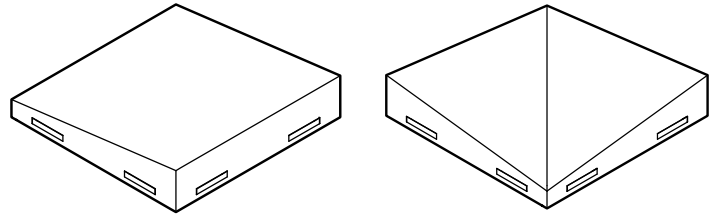

TUTTO DIMENSIONS  
WEIGHT: 2.8 LBS

VALLE DIMENSIONS  
WEIGHT: 2.8 LBS

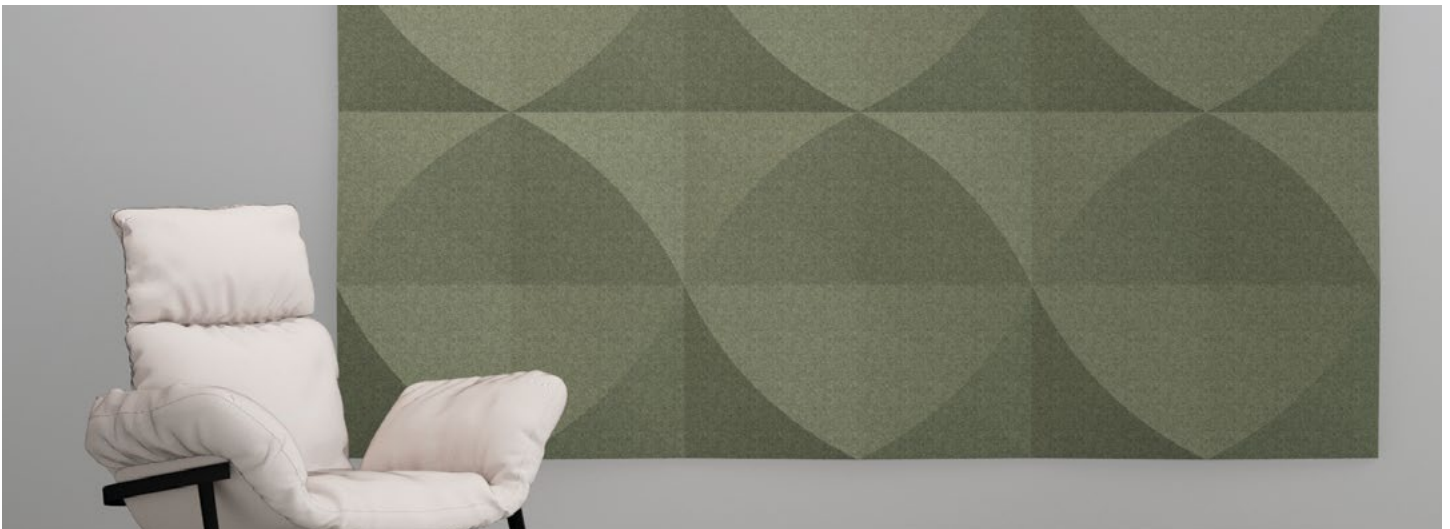

# PATTERN INSPIRATION

## UNLIMITED PATTERN OPTIONS

ROTATE PROFILES 90°, 180° OR 270°  
MIX AND MATCH TILE PROFILES

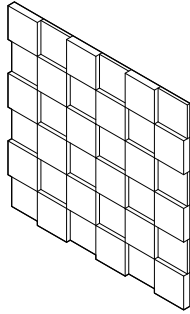

**PATTERN 01**  
ALTO - QTY 18  
BASSO - QTY 18

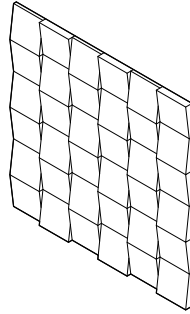

**PATTERN 02**  
TUTTO - QTY 36

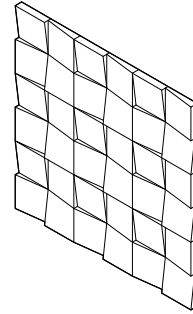

**PATTERN 03**  
TUTTO - QTY 36

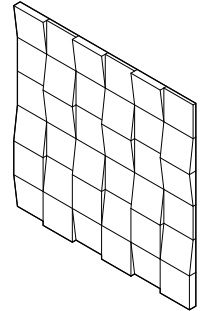

**PATTERN 04**  
ALTO - QTY 6  
BASSO - QTY 12  
TUTTO - QTY 18

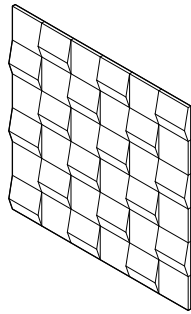

**PATTERN 05**  
BASSO - QTY 18  
CIMA - QTY 18

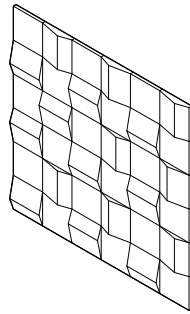

**PATTERN 06**  
BASSO - QTY 18  
CIMA - QTY 18

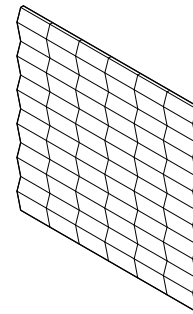

**PATTERN 07**  
CIMA - QTY 36

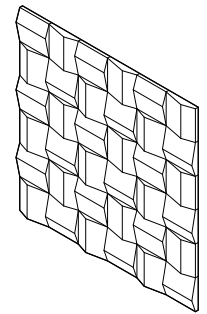

**PATTERN 08**  
CIMA - QTY 36

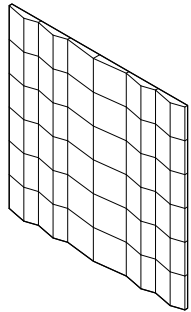

**PATTERN 09**  
CIMA - QTY 18  
TUTTO - QTY 18

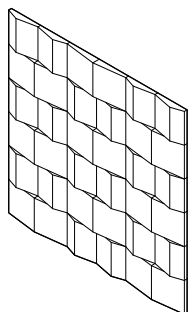

**PATTERN 10**  
CIMA - QTY 18  
TUTTO - QTY 18

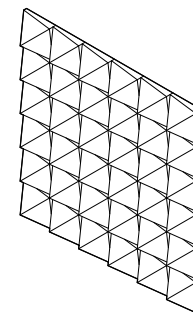

**PATTERN 11**  
PICCO - QTY 36

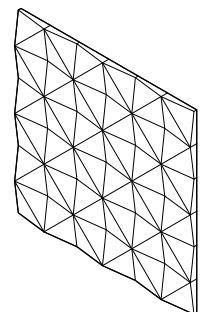

**PATTERN 12**  
PICCO - QTY 36

# PATTERN INSPIRATION CONTINUED

## UNLIMITED PATTERN OPTIONS

ROTATE PROFILES 90°, 180° OR 270°  
MIX AND MATCH TILE PROFILES

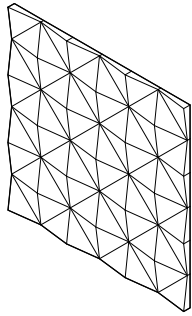

**PATTERN 13**  
VALLE - QTY 36

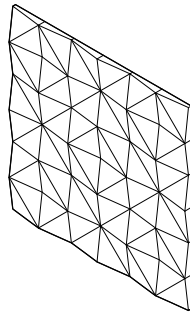

**PATTERN 14**  
PICCO - QTY 18  
VALLE - QTY 18

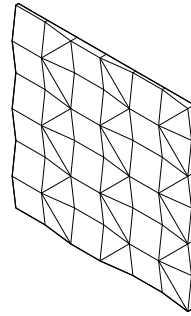

**PATTERN 15**  
PICCO - QTY 18  
TUTTO - QTY 18

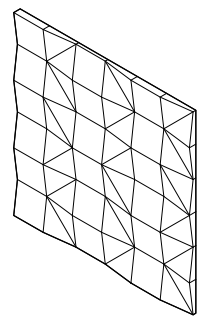

**PATTERN 16**  
TUTTO - QTY 18  
VALLE - QTY 18

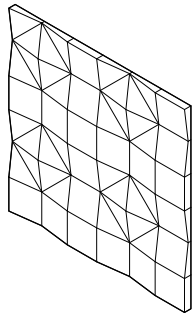

**PATTERN 17**  
BASSO - QTY 12  
TUTTO - QTY 6  
VALLE - QTY 18

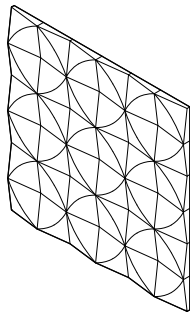

**PATTERN 18**  
ARCO - QTY 36

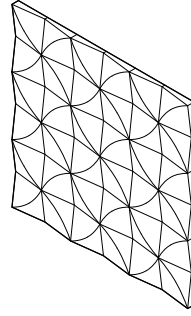

**PATTERN 19**  
ARCO - QTY 36

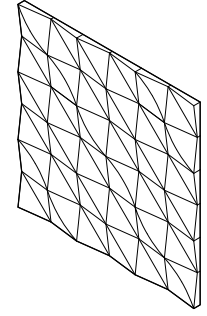

**PATTERN 20**  
ARCO - QTY 12  
PICCO - QTY 6  
VALLE - QTY 18

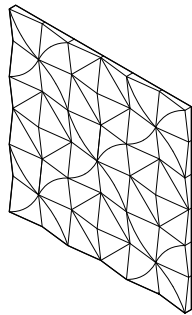

**PATTERN 21**  
ARCO - QTY 18  
VALLE - QTY 18

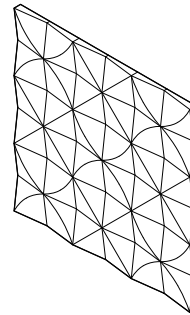

**PATTERN 22**  
ARCO - QTY 18  
PICCO - QTY 18

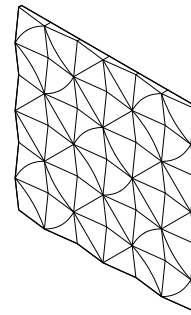

**PATTERN 23**  
ARCO - QTY 18  
PICCO - QTY 18

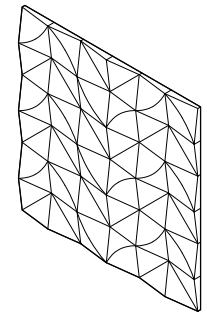

**PATTERN 24**  
ARCO - QTY 18  
VALLE - QTY 18

# INSTALL

## CLEAT OR DIRECT GLUE

1 CLEAT PER TILE

FACTORY APPLIED ADHESIVE BACKER

### ATTACHMENT INSTRUCTIONS

1. WIPE WALL CLEAN OF DUST & DIRT
2. IDENTIFY LOCATION OF MUTO CLEAT
3. PEEL ADHESIVE PROTECTIVE COVER
4. WITH PRESSURE APPLY TO WALL
5. ORIENT SPAZIO TILE AND HANG ON CLEAT

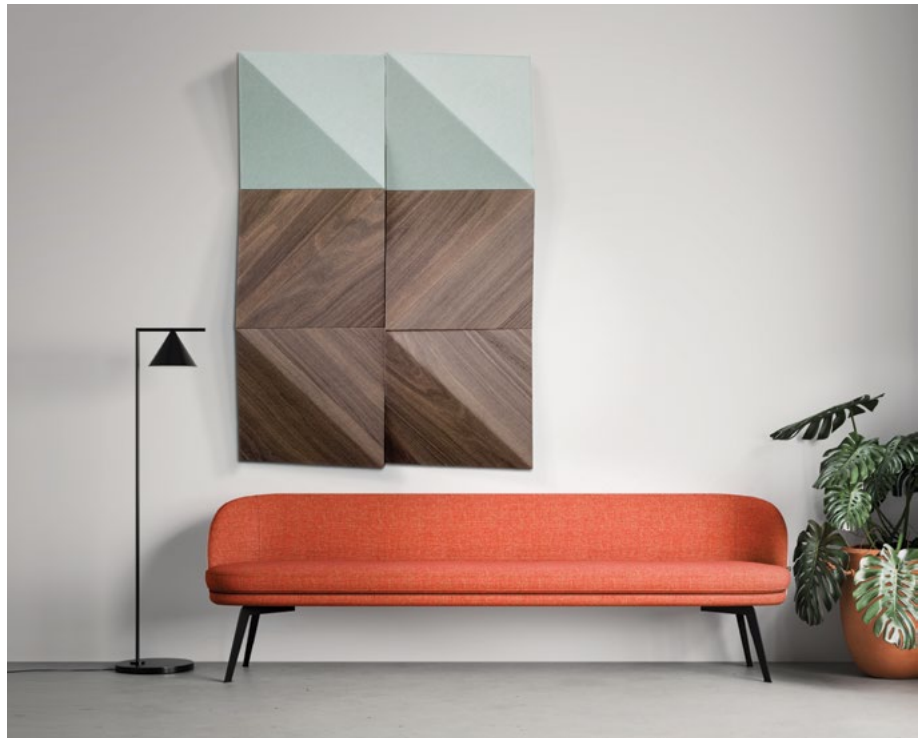
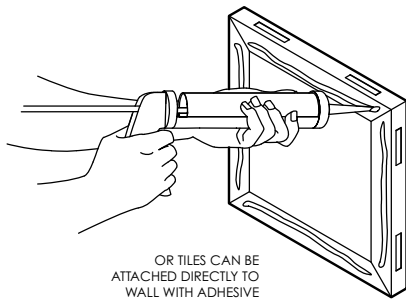
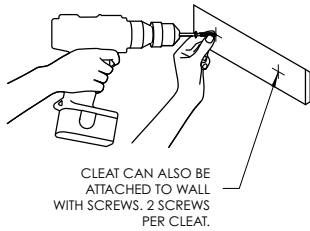
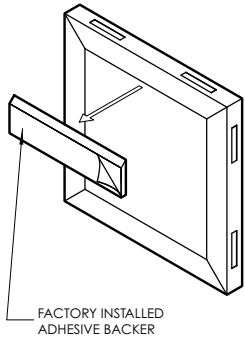

DETAIL: INSTALLATION

# ACOUSTICS

## NRC TEST DATA

Higher NRC ratings mean higher sound absorbency. The performance of 1/2" MUTO PET felt core material increases as the depth of air gap increases.

NRC values will vary based on customization and specific installation details. Contact your sales representative to learn more.

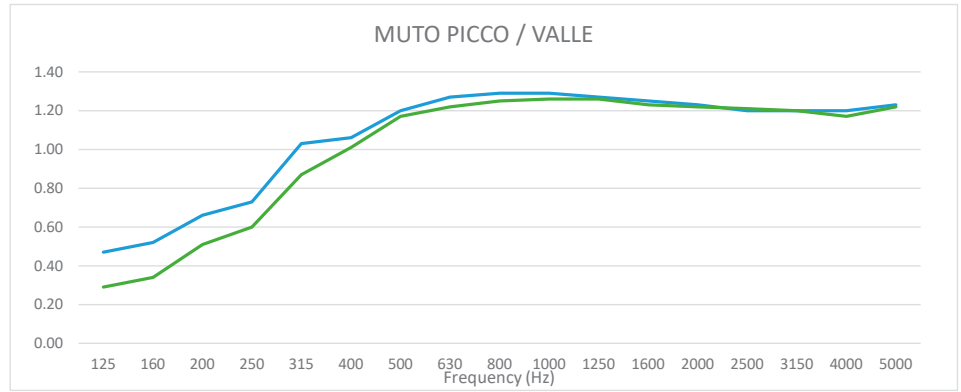

	SAMPLE FREQUENCY (Hz)				NRC	SAA
	250	500	1000	2000		
PICCO	0.73	1.20	1.29	1.23	1.10	1.12
VALLE	0.60	1.17	1.26	1.22	1.05	1.07

# ENVIRONMENTAL

## DECLARE, MINDFUL MATERIALS & GREENGUARD GOLD CERTIFIED

We care about the environment and it matters that our materials support healthy and productive interior spaces. We use innovative materials but ensure that they meet the highest level of standards and expectations.

MUTO PET felt core material is 100% recyclable with no added urea formaldehyde.

